

AUTHORIZED REPRESENTATIVE



LQS

WIRE SHELVING



www.logiquip.com

WHY LOGIQUIP®?



Healthcare exclusive since 1992, LogiQuip's **Inventory Management Solutions** are designed for Healthcare Professionals looking for a better way to manage supply chain tasks. With **Expert Advice**, **Innovative Solutions**, and **360° Service** that doesn't stop after the sale, LogiQuip's sole purpose is to ensure Healthcare Professionals have the supplies they need when they need them. Partnering with you to design and implement the right solutions, we give you time back to focus on what's important, Patient Care.

EXPERT ADVICE

With an in-depth understanding of the industry and a focus on **Infection Control** and **Lean Processes**, we partner with you to ensure we design the right solutions for you.

INNOVATIVE SOLUTIONS

Designed with an eye on the horizon, LogiQuip has **Innovative Solutions** that evolve with your facility. Our flexible and efficient options help to ensure you have the supplies you need when you need them.

360° SERVICE

LogiQuip's experienced **Sales Representatives** and **Award-Winning Customer Support Team** provide unparalleled service before, during, and after the sale.

LogiQuip is committed to fulfilling customer orders as quickly as possible which is why we have hundreds of products in stock, ready to ship every day. Please contact LogiQuip's Customer Experience Team or your Sales Representative to learn more.



WITH LABOR SHORTAGES AND THE EVER-INCREASING DEMAND TO DO MORE WITH LESS, the **LogiQuip Services Team** can help to decrease that burden with turnkey solutions to help ensure you have the supplies you need when you need them.

PROJECT MANAGEMENT

From our initial meeting with you through implementation, a LogiQuip **Services Team Member** will be assigned as your **Project Manager**, working with you every step of the way. Your **Project Manager** will serve as your single point of contact during the project life cycle. Together we will develop and implement project milestones until the work is complete. Contact your **Sales Representative** or call **(800) 665-3760** for more information.

ON-SITE ANALYSIS

Working with your LogiQuip **Representative**, an on-site analysis will be done to ensure that the **Project Manager** has a complete understanding of your current environment. During our on-site analysis we will review your current state, identify gaps, and align on the goals of the project.

PLANNING

Using a mix of innovative products, Lean principles, tried and true methods, and out of the box thinking, LogiQuip will provide a holistic plan with turnkey solutions to minimize downtime while decreasing your storage footprint and increasing PAR levels.

INSTALLATION & CONVERSION

LogiQuip is dedicated to providing on-time delivery, efficient installation, and supply conversion to minimize down time and time on site to get you up and running as quickly as possible.

ONGOING SUPPORT

With the project complete, we want to help you sustain the changes that have been made. With **Annual Inventory Reviews**, **Preventative Maintenance Plans**, and **Field Service** for in warranty and out of warranty repairs, we have you covered to keep things running smoothly.

TABLE OF CONTENTS

TABLE OF CONTENTS

| | |
|---|-------|
| WHY LOGIQUIP®? | 2 |
| LOGIQUIP SERVICES TEAM | 3 |
| LQS WIRE SHELVING FEATURES & BENEFITS | 5 |
| MOBILE LQS WIRE SHELVING | 6-7 |
| ENCLOSED LQS CART | 8-9 |
| SUTURE CARTS | 8-9 |
| STATIONARY LQS WIRE SHELVING | 10 |
| WATERFALL EDGE SHELVING | 11 |
| COMBINATION CARTS | 12 |
| DOLLY CARTS | 13 |
| SECURITY CARTS | 13 |
| UTILITY & CATHETER CARTS | 14 |
| LQS COMPONENTS | 15-18 |
| LQS ACCESSORIES | 19-31 |



LOGIQUIP® LQS WIRE SHELVING FEATURES & BENEFITS

LogiQuip's Standard (LQS) line of Wire Shelving is anything but standard. In addition to saving space, our LQS Wire Shelving and Posts begin with a Carbon Steel Core that is Double Chrome Plated for strength and durability that lasts. With a wide variety of configurations available to meet any of your organizational needs, our LQS Wire Shelving Line is flexible enough to be used virtually anywhere within your facility for easy and efficient storage.

CARBON STEEL CORE

All of LogiQuip's Wire Shelving and Posts starts with a Carbon Steel Core. This helps to ensure a strong, durable base for all of your storage needs.

DOUBLE CHROME PLATING

Each Carbon Steel Shelf and Post is Double Chrome Plated providing added strength. In addition to the smooth, bright finish that minimizes damage to stored items, Double Chrome Plating also helps to eliminate discoloration and peeling.

STRONG WIRE SHELVING

Strong Wire is used on all 36", 42", 48", 60", and 72" Flat Wire Shelves, allowing each shelf to hold between 600-800 pounds.

TWO-TRUSS SHELF DESIGN

LogiQuip's Two-Truss Shelf Design reinforces our 48", 54", 60", and 72" Shelves to provide added strength and support.

1-INCH ROUND POSTS

1-inch round Posts provide stability to the shelving unit. Compatible with all of our LQS Shelving, each Post is notched and numbered at 1" intervals for easy leveling of each Shelf.

UPGRADE WITH INTELLI-FLIP® SYSTEM

Our patented Intelli-Flip System combined with our Kanban Flippers with Adaptors, LQS Shelves and Baskets provides up-to-date inventory management. This powerful combination helps to reduce supply chain costs and stockouts.

LIMITED 5-YEAR WARRANTY

LogiQuip products are covered by a Limited 5-Year Warranty from date of receipt against defect in materials or workmanship under normal use and service, excluding Electronic Components, Cart Covers, Custom Products, LogiCell Tambour Doors, Label Holders, and Casters. During this period, LogiQuip will, in its sole discretion, repair defects in materials or workmanship that existed when the product was received or replace the product. Visit LogiQuip.com/Warranty for more details.



Enclosed Cart



Dolly Cart



LQS Basket Cart

MOBILE LQS WIRE SHELVING (STANDARD)

MOBILE LQS WIRE SHELVING STANDARD KITS

LogiQuip's LQS Mobile Wire Shelving Standard Kits are built to be moved. Our **Double Chrome Plated Carbon Steel Core Shelves and Posts** combine with heavy-duty **Casters** make each shelving unit ideal for storing items in one place or moving from location to location. Select a preexisting kit or build your own from the ground up with a wide variety of **Components** see pages 15-18.

STANDARD KITS include four (4) Double Chrome Plated Posts, four (4) 5" Casters – two (2) Swivel/Brake and two (2) Swivel, and four (4) **Donut Bumpers**.

| 4 SHELF, 69" HIGH | |
|-------------------|-----------------|
| MODEL | D x W x H - IN. |
| MB836CH | 18 x 36 x 69 |
| MB856CH | 18 x 48 x 69 |
| MB866CH | 18 x 60 x 69 |
| MB876CH | 18 x 72 x 69 |
| MB416CH | 24 x 24 x 69 |
| MB436CH | 24 x 36 x 69 |
| MB456CH | 24 x 48 x 69 |
| MB466CH | 24 x 60 x 69 |
| MB476CH | 24 x 72 x 69 |

| 5 SHELF, 80" HIGH | |
|-------------------|-----------------|
| MODEL | D x W x H - IN. |
| MB815CH | 18 x 24 x 80 |
| MB835CH | 18 x 36 x 80 |
| MB855CH | 18 x 48 x 80 |
| MB865CH | 18 x 60 x 80 |
| MB875CH | 18 x 72 x 80 |
| MB415CH | 24 x 24 x 80 |
| MB435CH | 24 x 36 x 80 |
| MB455CH | 24 x 48 x 80 |
| MB465CH | 24 x 60 x 80 |
| MB475CH | 24 x 72 x 80 |

| 4 SHELF, 80" HIGH | |
|-------------------|-----------------|
| MODEL | D x W x H - IN. |
| MB857CH | 18 x 48 x 80 |
| MB877CH | 18 x 72 x 80 |
| MB437CH | 24 x 36 x 80 |
| MB457CH | 24 x 48 x 80 |
| MB467CH | 24 x 60 x 80 |
| MB477CH | 24 x 72 x 80 |

| 6 SHELF, 80" HIGH | |
|-------------------|-----------------|
| MODEL | D x W x H - IN. |
| MB855CH-6 | 18 x 48 x 80 |
| MB455CH-6 | 24 x 48 x 80 |
| MB465CH-6 | 24 x 60 x 80 |

| 5 SHELF, 69" HIGH | |
|-------------------|-----------------|
| MODEL | D x W x H - IN. |
| MB816CH-5 | 18 x 24 x 69 |
| MB836CH-5 | 18 x 36 x 69 |
| MB466CH-5 | 24 x 60 x 69 |

| 7 SHELF, 80" HIGH | |
|-------------------|-----------------|
| MODEL | D x W x H - IN. |
| MB865CH-7 | 18 x 60 x 80 |
| MB415CH-7 | 24 x 24 x 80 |
| MB435CH-7 | 24 x 36 x 80 |
| MB455CH-7 | 24 x 48 x 80 |
| MB465CH-7 | 24 x 60 x 80 |
| MB475CH-7 | 24 x 72 x 80 |

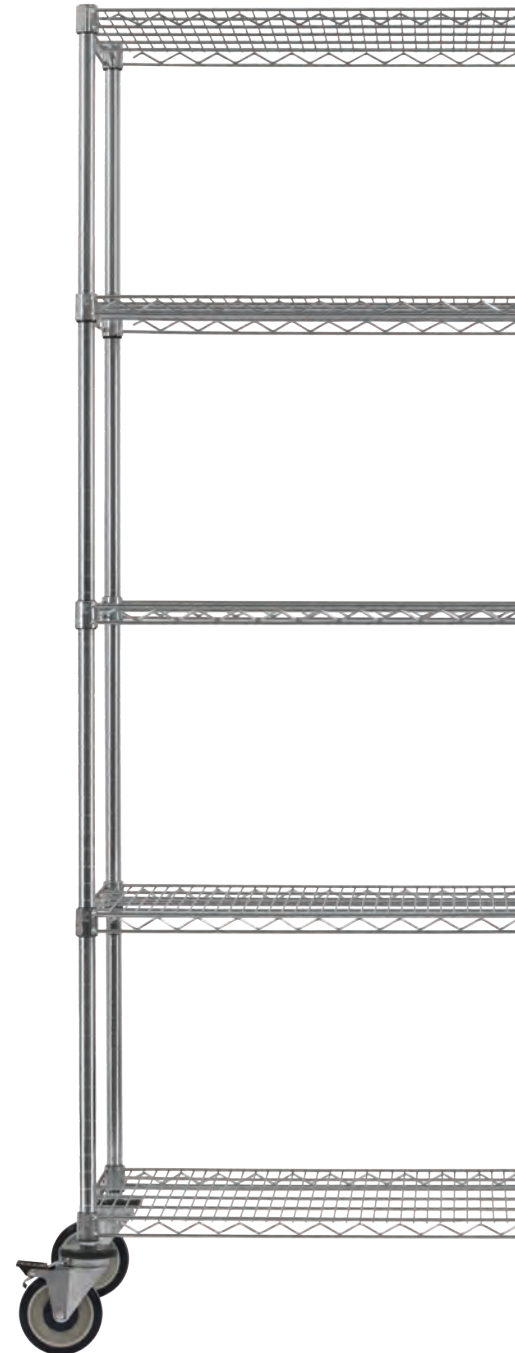

MAXIMUM WEIGHTS (STANDARD & COMPLETE KITS)

- Kit Maximum Weight – 750 Pounds
- 24" and 36" Shelves Maximum Weight – 800 Pounds
- 48", 60" and 72" Shelves Maximum Weight – 600 Pounds

MOBILE LQS WIRE SHELVING (COMPLETE)

MOBILE LQS WIRE SHELVING COMPLETE KITS

LogiQuip's Mobile LQS Wire Shelving Complete Kits take our **Standard Kits** to the next level with the addition of a **Dust Cover** and **Full-Length Label Holders**. Building on the benefits of our **Standard Kits**, the **Dust Cover** is placed on the bottom shelf for easy cleaning of dust and debris that falls through the shelving. The addition of **Label Holders** allows you to efficiently organize all stored items for easy access. Select a preexisting kit or build your own with a wide variety of **Components** see pages 15-18.

COMPLETE KITS include one (1) Dust Cover, one (1) Full Width Label Holder per Shelf, four (4) Double Chrome Plated Posts, four (4) 5" Casters – two (2) Swivel/Brake and two (2) Swivel, and four (4) **Donut Bumpers**.



| 4 SHELF, 69" HIGH | |
|-------------------|-----------------|
| MODEL | D x W x H - IN. |
| MB816CH-CL | 18 x 24 x 69 |
| MB826CH-CL | 18 x 30 x 69 |
| MB836CH-CL | 18 x 36 x 69 |
| MB856CH-CL | 18 x 48 x 69 |
| MB866CH-CL | 18 x 60 x 69 |
| MB876CH-CL | 18 x 72 x 69 |
| MB416CH-CL | 24 x 24 x 69 |
| MB426CH-CL | 24 x 30 x 69 |
| MB436CH-CL | 24 x 36 x 69 |
| MB446CH-CL | 24 x 42 x 69 |
| MB4546CH-CL | 24 x 54 x 69 |
| MB456CH-CL | 24 x 48 x 69 |
| MB466CH-CL | 24 x 60 x 69 |
| MB476CH-CL | 24 x 72 x 69 |

| 5 SHELF, 69" HIGH | |
|-------------------|-----------------|
| MODEL | D x W x H - IN. |
| MB816CH-5-CL | 18 x 24 x 69 |
| MB836CH-5-CL | 18 x 36 x 69 |
| MB466CH-5-CL | 24 x 60 x 69 |

| 6 SHELF, 80" HIGH | |
|-------------------|-----------------|
| MODEL | D x W x H - IN. |
| MB835CH-6-CL | 18 x 36 x 80 |
| MB455CH-6-CL | 24 x 48 x 80 |
| MB465CH-6-CL | 24 x 60 x 80 |
| MB475CH-6-CL | 24 x 72 x 80 |

| 7 SHELF, 69" HIGH | |
|-------------------|-----------------|
| MODEL | D x W x H - IN. |
| MB466CH-7-CL | 24 x 60 x 69 |

| 4 SHELF, 80" HIGH | |
|-------------------|-----------------|
| MODEL | D x W x H - IN. |
| MB837CH-CL | 18 x 36 x 80 |
| MB857CH-CL | 18 x 48 x 80 |
| MB457CH-CL | 24 x 48 x 80 |
| MB467CH-CL | 24 x 60 x 80 |
| MB477CH-CL | 24 x 72 x 80 |

| 5 SHELF, 80" HIGH | |
|-------------------|-----------------|
| MODEL | D x W x H - IN. |
| MB815CH-CL | 18 x 24 x 80 |
| MB825CH-CL | 18 x 30 x 80 |
| MB835CH-CL | 18 x 36 x 80 |
| MB845CH-CL | 18 x 42 x 80 |
| MB855CH-CL | 18 x 48 x 80 |
| MB865CH-CL | 18 x 60 x 80 |
| MB875CH-CL | 18 x 72 x 80 |
| MB415CH-CL | 24 x 24 x 80 |
| MB425CH-CL | 24 x 30 x 80 |
| MB435CH-CL | 24 x 36 x 80 |
| MB445CH-CL | 24 x 42 x 80 |
| MB455CH-CL | 24 x 48 x 80 |
| MB4545CH-CL | 24 x 54 x 80 |
| MB465CH-CL | 24 x 60 x 80 |
| MB475CH-CL | 24 x 72 x 80 |

| 7 SHELF, 80" HIGH | |
|-------------------|-----------------|
| MODEL | D x W x H - IN. |
| MB415CH-7-CL | 24 x 24 x 80 |
| MB435CH-7-CL | 24 x 36 x 80 |
| MB455CH-7-CL | 24 x 48 x 80 |
| MB465CH-7-CL | 24 x 60 x 80 |
| MB475CH-7-CL | 24 x 72 x 80 |

ENCLOSED LQS CARTS (STANDARD)

ENCLOSED LQS CART STANDARD KITS

All **Enclosed LQS Cart Standard Kits** are 24" deep and enclosed with a wire grid on three sides. This **Kit** contains shelves with four (4) posts, two (2) brake casters, and two (2) swivel casters with four (4) **Donut Bumpers**. Other sizes can be built from **Components** see pages 15-18.

| 4 SHELF, 69" HIGH | |
|-------------------|-----------------|
| MODEL | D x W x H - IN. |
| MEB456CH | 24 x 48 x 69 |
| MEB466CH | 24 x 60 x 69 |
| MEB476CH | 24 x 72 x 69 |

| 6 SHELF, 80" HIGH | |
|-------------------|-----------------|
| MODEL | D x W x H - IN. |
| MEB455CH-6 | 24 x 48 x 80 |
| MEB465CH-6 | 24 x 60 x 80 |
| MEB475CH-6 | 24 x 72 x 80 |

| 4 SHELF, 80" HIGH | |
|-------------------|-----------------|
| MODEL | D x W x H - IN. |
| MEB457CH | 24 x 48 x 80 |

| 7 SHELF, 80" HIGH | |
|-------------------|-----------------|
| MODEL | D x W x H - IN. |
| MEB455CH-7 | 24 x 48 x 80 |
| MEB465CH-7 | 24 x 60 x 80 |
| MEB475CH-7 | 24 x 72 x 80 |

| 5 SHELF, 80" HIGH | |
|-------------------|-----------------|
| MODEL | D x W x H - IN. |
| MEB465CH | 24 x 60 x 80 |
| MEB475CH | 24 x 72 x 80 |

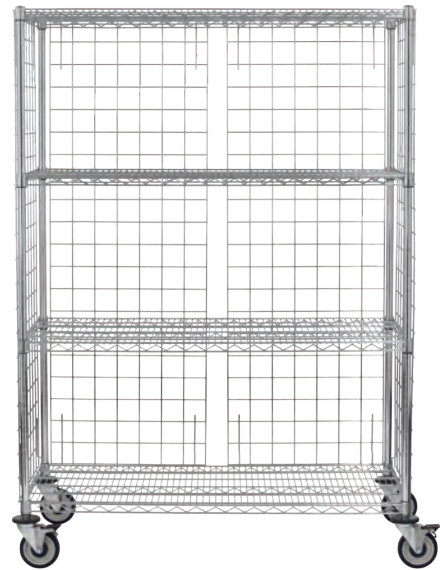

MAXIMUM WEIGHTS (STANDARD & COMPLETE KITS)

- Kit Maximum Weight - 750 Pounds
- 24" and 36" Shelves Maximum Weight - 800 Pounds
- 48", 60" and 72" Shelves Maximum Weight - 600 Pounds

SUTURE CARTS + KITS (SINGLE-SIDED)

SUTURE CARTS + SINGLE-SIDED SUTURE CART KITS

All **Suture Carts** are 69" high, have two (2) brake and two (2) swivel 5" **Casters** with four (4) **Donut Bumpers**, and a bottom wire shelf with **Shelf Cover**. Other sizes can be built from **Components** see pages 15-18.

The **Single-Sided Suture Cart** includes a **Label Holder** for each basket.

| 4 SHELF, 69" HIGH | |
|-------------------|-----------------|
| MODEL | D x W x H - IN. |
| SL424CH | 18 x 24 x 69 |
| SL436CH | 18 x 36 x 69 |

| 5 SHELF, 69" HIGH | |
|-------------------|-----------------|
| MODEL | D x W x H - IN. |
| SL524CH | 18 x 24 x 69 |
| SL548CH | 18 x 48 x 69 |



ENCLOSED LQS CARTS (COMPLETE)

ENCLOSED LQS CART COMPLETE KITS

The Complete Kit comes with everything in the Standard Kit plus a Shelf Cover for the bottom shelf and a full-width Label Holder for each shelf. Other sizes can be built from Components see pages 15-18.

| 4 SHELF, 69" HIGH | |
|-------------------|-----------------|
| MODEL | D x W x H - IN. |
| MEB416CH-CL | 24 x 24 x 69 |
| MEB456CH-CL | 24 x 48 x 69 |
| MEB466CH-CL | 24 x 60 x 69 |
| MEB476CH-CL | 24 x 72 x 69 |

| 4 SHELF, 80" HIGH | |
|-------------------|-----------------|
| MODEL | D x W x H - IN. |
| MEB837CH-CL | 18 x 36 x 80 |
| MEB457CH-CL | 24 x 48 x 80 |

| 6 SHELF, 80" HIGH | |
|-------------------|-----------------|
| MODEL | D x W x H - IN. |
| MEB455CH-6-CL | 24 x 48 x 80 |
| MEB465CH-6-CL | 24 x 60 x 80 |
| MEB475CH-6-CL | 24 x 72 x 80 |

| 7 SHELF, 80" HIGH | |
|-------------------|-----------------|
| MODEL | D x W x H - IN. |
| MEB465CH-7-CL | 24 x 60 x 80 |
| MEB475CH-7-CL | 24 x 72 x 80 |

| 5 SHELF, 69" HIGH | |
|-------------------|-----------------|
| MODEL | D x W x H - IN. |
| MEB466CH-5-CL | 24 x 60 x 69 |

| 5 SHELF, 80" HIGH | |
|-------------------|-----------------|
| MODEL | D x W x H - IN. |
| MEB1455CH-CL | 14 x 48 x 80 |
| MEB1465CH-CL | 14 x 60 x 80 |
| MEB825CH-CL | 18 x 30 x 80 |
| MEB835CH-CL | 18 x 36 x 80 |
| MEB845CH-CL | 18 x 42 x 80 |
| MEB855CH-CL | 18 x 48 x 80 |
| MEB8545CH-CL | 18 x 54 x 80 |
| MEB865CH-CL | 18 x 60 x 80 |
| MEB875CH-CL | 18 x 72 x 80 |
| MEB415CH-CL | 24 x 24 x 80 |
| MEB425CH-CL | 24 x 30 x 80 |
| MEB435CH-CL | 24 x 36 x 80 |
| MEB445CH-CL | 24 x 42 x 80 |
| MEB455CH-CL | 24 x 48 x 80 |
| MEB4545CH-CL | 24 x 54 x 80 |
| MEB465CH-CL | 24 x 60 x 80 |
| MEB475CH-CL | 24 x 72 x 80 |



SUTURE CART KITS (DOUBLE-SIDED)

DOUBLE-SIDED SUTURE CART KITS

The Double-Sided Suture Cart has Label Holders on both sides, a top wire shelf, and enclosure panels on each side.

| 4 SHELF, 69" HIGH | |
|-------------------|-----------------|
| MODEL | D x W x H - IN. |
| STR424CH | 24 x 24 x 69 |
| STR536CH | 24 x 36 x 69 |
| STR548CH | 24 x 48 x 69 |

| 5 SHELF, 69" HIGH | |
|-------------------|-----------------|
| MODEL | D x W x H - IN. |
| STR524CH | 24 x 36 x 69 |



STATIONARY LQS WIRE SHELVING

STATIONARY LQS WIRE SHELVING STANDARD KITS

The Standard Stationary LQS Wire Shelving Kit contains shelves with four (4) posts. Other sizes can be built from Components see pages 15-18.

| 4 SHELF, 63" HIGH | |
|-------------------|-----------------|
| MODEL | D x W x H - IN. |
| 816CH | 18 x 24 x 63 |
| 836CH | 18 x 36 x 63 |
| 876CH | 18 x 72 x 63 |

| 4 SHELF, 74" HIGH | |
|-------------------|-----------------|
| MODEL | D x W x H - IN. |
| 837CH | 18 x 36 x 74 |
| 857CH | 18 x 48 x 74 |
| 867CH | 18 x 60 x 74 |
| 877CH | 18 x 72 x 74 |
| 457CH | 24 x 48 x 74 |
| 467CH | 24 x 60 x 74 |

| 5 SHELF, 74" HIGH | |
|-------------------|-----------------|
| MODEL | D x W x H - IN. |
| 835CH | 18 x 36 x 74 |
| 865CH | 18 x 60 x 74 |
| 875CH | 18 x 72 x 74 |
| 425CH | 24 x 30 x 74 |
| 435CH | 24 x 36 x 74 |
| 445CH | 24 x 42 x 74 |
| 455CH | 24 x 48 x 74 |
| 465CH | 24 x 60 x 74 |
| 475CH | 24 x 72 x 74 |

| 6 SHELF, 74" HIGH | |
|-------------------|-----------------|
| MODEL | D x W x H - IN. |
| 455CH-6 | 24 x 48 x 74 |
| 465CH-6 | 24 x 60 x 74 |
| 475CH-6 | 24 x 72 x 74 |



STATIONARY LQS WIRE SHELVING COMPLETE KITS

The Complete Stationary LQS Wire Shelving Kit also includes a Shelf Cover for the bottom shelf, and a full-width Label Holder for each shelf. Other sizes can be built from Components see pages 15-18.

| 4 SHELF, 63" HIGH | |
|-------------------|-----------------|
| MODEL | D x W x H - IN. |
| 836CH-CL | 18 x 36 x 63 |

| 4 SHELF, 74" HIGH | |
|-------------------|-----------------|
| MODEL | D x W x H - IN. |
| 817CH-CL | 18 x 24 x 74 |
| 857CH-CL | 18 x 48 x 74 |
| 867CH-CL | 18 x 60 x 74 |
| 877CH-CL | 18 x 72 x 74 |
| 417CH-CL | 24 x 24 x 74 |
| 457CH-CL | 24 x 48 x 74 |
| 467CH-CL | 24 x 60 x 74 |

| 6 SHELF, 74" HIGH | |
|-------------------|-----------------|
| MODEL | D x W x H - IN. |
| 455CH-6-CL | 24 x 48 x 74 |
| 465CH-6-CL | 24 x 60 x 74 |
| 475CH-6-CL | 24 x 72 x 74 |

| 5 SHELF, 74" HIGH | |
|-------------------|-----------------|
| MODEL | D x W x H - IN. |
| 1455CH-CL | 14 x 48 x 74 |
| 1465CH-CL | 14 x 60 x 74 |
| 815CH-CL | 18 x 24 x 74 |
| 825CH-CL | 18 x 30 x 74 |
| 835CH-CL | 18 x 36 x 74 |
| 845CH-CL | 18 x 42 x 74 |
| 855CH-CL | 18 x 48 x 74 |
| 865CH-CL | 18 x 60 x 74 |
| 875CH-CL | 18 x 72 x 74 |
| 415CH-CL | 24 x 24 x 74 |
| 425CH-CL | 24 x 30 x 74 |
| 435CH-CL | 24 x 36 x 74 |
| 445CH-CL | 24 x 42 x 74 |
| 455CH-CL | 24 x 48 x 74 |
| 465CH-CL | 24 x 60 x 74 |
| 475CH-CL | 24 x 72 x 74 |

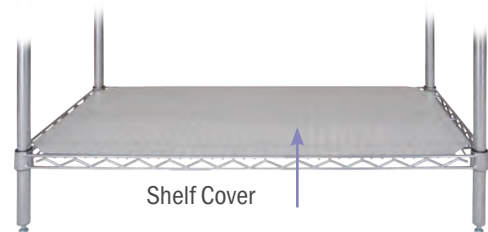

WATERFALL EDGE SHELVING

WATERFALL EDGE SHELVING KITS

The LogiQuip® Waterfall Edge Shelving features a smooth, rounded edge along the width of the shelf, replacing the traditional raised edge that can damage items as they are moved in and out of storage. These strong and durable **Shelves** come in a variety of sizes and are available in pre-configured kits. All **Kit Models** are mobile, have four (4) casters; two (2) swivel/brake, two (2) swivel with four (4) **Donut Bumpers**, and a **Shelf Cover**.



6 SHELF, 69" HIGH

| MODEL | | D x W x H - IN. |
|------------|-------------------------------------|-----------------|
| MB456CWC-4 | 2 Flat Shelves, 4 Waterfall Shelves | 24 x 48 x 69 |
| MB466CWC-4 | 2 Flat Shelves, 4 Waterfall Shelves | 24 x 60 x 69 |
| MB476CWC-4 | 2 Flat Shelves, 4 Waterfall Shelves | 24 x 72 x 69 |

6 SHELF, 80" HIGH

| MODEL | | D x W x H - IN. |
|------------|-------------------------------------|-----------------|
| MB457CWC-4 | 2 Flat Shelves, 4 Waterfall Shelves | 24 x 48 x 80 |
| MB467CWC-4 | 2 Flat Shelves, 4 Waterfall Shelves | 24 x 60 x 80 |
| MB477CWC-4 | 2 Flat Shelves, 4 Waterfall Shelves | 24 x 72 x 80 |

8 SHELF, 80" HIGH

| MODEL | | D x W x H - IN. |
|------------|-------------------------------------|-----------------|
| MB457CWC-6 | 2 Flat Shelves, 6 Waterfall Shelves | 24 x 48 x 80 |
| MB467CWC-6 | 2 Flat Shelves, 6 Waterfall Shelves | 24 x 60 x 80 |
| MB477CWC-6 | 2 Flat Shelves, 6 Waterfall Shelves | 24 x 72 x 80 |

COMBINATION CARTS

COMBINATION CARTS

Combination Carts, with Standard Supply Baskets, Shelves, and Dividers, plus four (4) 5" casters; two (2) brake/swivel and two (2) swivel with four (4) Donut Bumpers. The bottom shelf comes with a Shelf Cover, and the top shelf is flat wire. All Baskets and Shelves include Label Holders. See pages 19-31 for more Accessories.

| 7 TIER 80" HIGH | | |
|-----------------|-----------------------------------|-----------------|
| MODEL | DESCRIPTION | D x W x H - IN. |
| AF409CH | 3 Shelves, 4 Baskets, 12 Dividers | 18 x 36 x 80 |
| AF508CH | 2 Shelves, 5 Baskets, 10 Dividers | 18 x 24 x 80 |
| AF509CH | 2 Shelves, 5 Baskets, 15 Dividers | 18 x 36 x 80 |
| AF410CH | 3 Shelves, 4 Baskets, 16 Dividers | 18 x 48 x 80 |
| AF510CH | 2 Shelves, 5 Baskets, 20 Dividers | 18 x 48 x 80 |
| AF411CH | 3 Shelves, 4 Baskets, 20 Dividers | 18 x 60 x 80 |
| AF511CH | 2 Shelves, 5 Baskets, 25 Dividers | 18 x 60 x 80 |
| AF2508CH | 2 Shelves, 5 Baskets, 10 Dividers | 24 x 24 x 80 |
| AF2408CH | 3 Shelves, 4 Baskets, 8 Dividers | 24 x 24 x 80 |
| AF2409CH | 3 Shelves, 4 Baskets, 12 Dividers | 24 x 36 x 80 |
| AF2509CH | 2 Shelves, 5 Baskets, 15 Dividers | 24 x 36 x 80 |
| AF2020CH | 5 Shelves, 5 Baskets, 10 Dividers | 24 x 48 x 80 |
| AF2410CH | 3 Shelves, 4 Baskets, 16 Dividers | 24 x 48 x 80 |
| AF2510CH | 2 Shelves, 5 Baskets, 20 Dividers | 24 x 48 x 80 |
| AF2411CH | 3 Shelves, 4 Baskets, 20 Dividers | 24 x 60 x 80 |
| AF2511CH | 2 Shelves, 5 Baskets, 25 Dividers | 24 x 60 x 80 |



Model #
AF2020CH

| 8 TIER 80" HIGH | | |
|-----------------|-----------------------------------|-----------------|
| MODEL | DESCRIPTION | D x W x H - IN. |
| AF008CH | 2 Shelves, 6 Baskets, 12 Dividers | 18 x 24 x 80 |
| AF009CH | 2 Shelves, 6 Baskets, 18 Dividers | 18 x 36 x 80 |
| AF010CH | 2 Shelves, 6 Baskets, 24 Dividers | 18 x 48 x 80 |
| AF011CH | 2 Shelves, 6 Baskets, 30 Dividers | 18 x 60 x 80 |
| AF2008CH | 2 Shelves, 6 Baskets, 12 Dividers | 24 x 24 x 80 |
| AF2009CH | 2 Shelves, 6 Baskets, 18 Dividers | 24 x 36 x 80 |
| AF2010CH | 2 Shelves, 6 Baskets, 24 Dividers | 24 x 48 x 80 |
| AF2011CH | 2 Shelves, 6 Baskets, 30 Dividers | 24 x 60 x 80 |



Model #
AF2510CH

DOLLY & SECURITY CARTS

DOLLY CARTS

LogiQuip Dolly Carts come with **Solid Bases** for added strength and stability when moving supplies from location to location. Each **Dolly Cart** has non-marking, wrap-around bumpers, four (4) 5" casters, and a weight capacity of 750 pounds. Custom configurations available upon request, including 6" caster options with a weight capacity of 1,200 pounds.

| SOLID DOLLY CARTS, SS INSERT | | |
|------------------------------|-------------|-----------------|
| MODEL | DESCRIPTION | D x W x H - IN. |
| MDS435CH | 5 Shelves | 24 x 36 x 81 |
| MDS475CH | 5 Shelves | 24 x 72 x 81 |



Model # MDS455CH

SECURITY CARTS

Security Carts are fully enclosed and lockable security units. Ideal for controlled access for PPE and Ventilators, these carts can be moved across your facility with ease. All **Security Carts** ship fully assembled.

| 36" WIDE | | |
|------------|-------------|-----------------|
| MODEL | DESCRIPTION | D x W x H - IN. |
| MSEC364FCH | 4 Shelves | 24 x 36 x 69 |
| MSEC365FCH | 5 Shelves | 24 x 36 x 69 |

| 48" WIDE | | |
|------------|-------------|-----------------|
| MODEL | DESCRIPTION | D x W x H - IN. |
| MSEC484FCH | 4 Shelves | 24 x 48 x 69 |
| MSEC485FCH | 5 Shelves | 24 x 48 x 69 |

| 60" WIDE | | |
|------------|-------------|-----------------|
| MODEL | DESCRIPTION | D x W x H - IN. |
| MSEC604FCH | 4 Shelves | 24 x 60 x 69 |
| MSEC605FCH | 5 Shelves | 24 x 60 x 69 |



Model #
MSEC484FCH

UTILITY CARTS & CATHETER CARTS

DUAL HANDLE UTILITY CARTS

LogiQuip's **Dual Handle Utility Carts** are available in **Chrome** or **Epoxy Coated** and have four (4) 40" high standard posts, two (2) "U" handles, four (4) 5" casters; two (2) brake/swivel and two (2) swivel with four (4) **Donut Bumpers**.

| DUAL HANDLE | | | |
|-------------|--------------|------------------------|-----------------|
| CHROME | EPOXY COATED | DESCRIPTION | D x W x H - IN. |
| RD282CH | — | Dual Handle, 2 Shelves | 18 x 24 x 40 |
| RD383CH | — | Dual Handle, 3 Shelves | 18 x 30 x 40 |
| RD284CH | RD284ES | Dual Handle, 2 Shelves | 18 x 36 x 40 |
| RD384CH | RD384ES | Dual Handle, 3 Shelves | 18 x 36 x 40 |
| RD244CH | — | Dual Handle, 2 Shelves | 24 x 36 x 40 |
| RD344CH | RD344ES | Dual Handle, 3 Shelves | 24 x 36 x 40 |
| RD246CH | RD245ES | Dual Handle, 2 Shelves | 24 x 48 x 40 |



Model #
RD384CH

SINGLE HANDLE UTILITY CARTS

The **Single Handle Utility Cart** has four (4) 30" high standard posts and one (1) "U" handle and the same casters, four (4) 5" casters; two (2) brake/swivel and two (2) swivel with four (4) **Donut Bumpers**.

| SINGLE HANDLE | | |
|---------------|-----------|-----------------|
| 2 SHELVES | 3 SHELVES | D x W x H - IN. |
| C282CH | C382CH | 18 x 24 x 40 |
| — | C383CH | 18 x 30 x 40 |
| C284CH | C384CH | 18 x 36 x 40 |
| C244CH | C344CH | 24 x 36 x 40 |
| C246CH | C346CH | 24 x 48 x 40 |



Model #
C383CH

LQS CATHETER CARTS

An easy, mobile solution for **Catheter Storage LQS Catheter Carts** come with 40 **Catheter hooks**, 24" and 60" wide **Shelves**. This product ships fully assembled.

| CATHETER CARTS | |
|----------------|-----------------|
| MODEL | D x W x H - IN. |
| CATCOMB2CH | 18 x 60 x 80 |
| CATCOMB3CH | 18 x 60 x 80 |



Model #
CATCOMB2CH

LQS COMPONENTS

WALL MOUNTING SHELVES

LogiQuip **Wall Mounting Shelves** includes two (2) 14" and 18" deep shelves, two (2) 27" posts, four (4) brackets, and four (4) cantilever arms. Wall mounting bolts not included. User must determine if the wall can support the load and anchoring requirements.

| 2-SHELF WALL MOUNTED UNIT | |
|---------------------------|-----------------|
| MODEL | D x W x H - IN. |
| 2WA1424CH | 14 x 24 x 27 |
| 2WA1430CH | 14 x 30 x 27 |
| 2WA1436CH | 14 x 36 x 27 |
| 2WA1448CH | 14 x 48 x 27 |
| 2WA1836CH | 18 x 36 x 27 |
| 2WA1848CH | 18 x 48 x 27 |

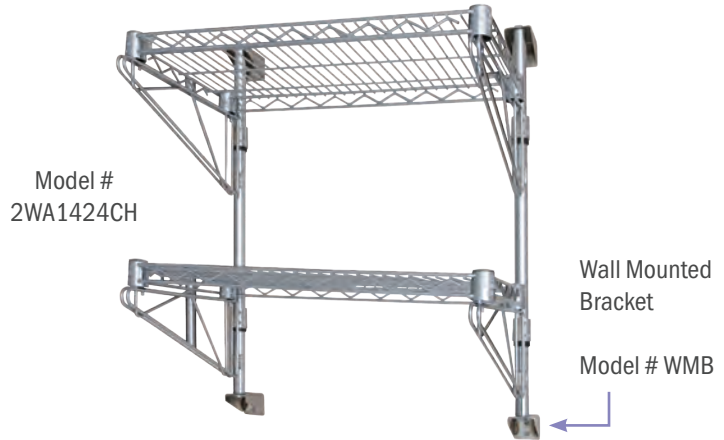

SLOPED SUTURE SHELVES

These 10" high chrome **Shelves** are **Sloped**, making them ideal to store sutures. Single-sided **Sloped Suture Shelves** are 18" deep, double-sided **Sloped Suture Shelves** are 24" deep.

| 18" DEEP | |
|----------|-----------------|
| MODEL | D x W x H - IN. |
| SL24CH | 18 x 24 x 10 |
| SL36CH | 18 x 36 x 10 |
| SL48CH | 18 x 48 x 10 |

| 24" DEEP | |
|----------|-----------------|
| MODEL | D x W x H - IN. |
| STR24CH | 24 x 24 x 10 |
| STR36CH | 24 x 36 x 10 |
| STR48CH | 24 x 48 x 10 |

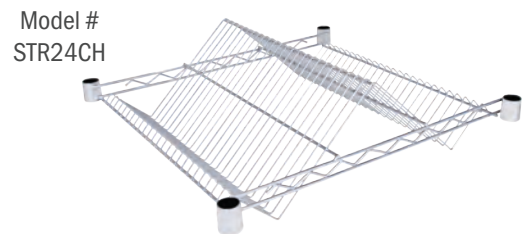

WIRE SHELVING ENCLOSURE PANELS

Leverage a combination of **LQS Wire Shelving Back and End Enclosure Panels** to create a custom **Enclosed Cart**.

| BACK PANELS | | | |
|-------------|-------------|-----------|-------------|
| MODEL | D x W - IN. | MODEL | D x W - IN. |
| BRD3060CH | 30 x 60 | BRD4872CH | 48 x 72 |
| BRD3072CH | 30 x 72 | BRD5472CH | 54 x 72 |
| BRD3660CH | 36 x 60 | BRD6060CH | 60 x 60 |
| BRD3672CH | 36 x 72 | BRD6072CH | 60 x 72 |
| BRD4260CH | 42 x 60 | BRD7260CH | 72 x 60 |
| BRD4272CH | 42 x 72 | BRD7272CH | 72 x 72 |
| BRD4860CH | 48 x 60 | | |

| END PANELS | |
|------------|-------------|
| MODEL | D x W - IN. |
| ERD1460CH | 14 x 16 |
| ERD1472CH | 14 x 72 |
| ERD1860CH | 18 x 60 |
| ERD1872CH | 18 x 72 |
| ERD2460CH | 24 x 60 |
| ERD2472CH | 24 x 72 |



LQS COMPONENTS

WIRE SHELVES

LogiQuip® **Wire Shelves** are adjustable on 1" increments and come in a variety of sizes and finishes (Chrome, Stainless) to suit every application. Each **Shelf** comes with four (4) split sleeves to attach the shelf to the **Pole**.

| 14" DEEP | | |
|----------|--------------|------------|
| CHROME | D x W INCHES | MAXWT LBS. |
| 1424CH | 14 x 24 | 800 |
| 1430CH | 14 x 30 | 800 |
| 1436CH | 14 x 36 | 800 |
| 1448CH | 14 x 48 | 800 |
| 1454CH | 14 x 54 | 600 |
| 1460CH | 14 x 60 | 600 |

| 18" DEEP | | |
|----------|--------------|------------|
| CHROME | D x W INCHES | MAXWT LBS. |
| 1824CH | 18 x 24 | 800 |
| 1830CH | 18 x 30 | 800 |
| 1836CH | 18 x 36 | 800 |
| 1842CH | 18 x 42 | 800 |
| 1848CH | 18 x 48 | 800 |
| 1860CH | 18 x 60 | 600 |
| 1872CH | 18 x 72 | 600 |

| 24" DEEP | | | |
|----------|-----------|--------------|------------|
| CHROME | STAINLESS | D x W INCHES | MAXWT LBS. |
| 2424CH | - | 24 x 24 | 800 |
| 2430CH | - | 24 x 30 | 800 |
| 2436CH | 2436SW | 24 x 36 | 800 |
| 2442CH | - | 24 x 42 | 800 |
| 2448CH | 2448SW | 24 x 48 | 800 |
| 2454CH | - | 24 x 54 | 600 |
| 2460CH | - | 24 x 60 | 600 |
| 2472CH | - | 24 x 72 | 600 |

WATERFALL EDGE SHELVES

LogiQuip's **Waterfall Edge Shelf** design allows fragile items, like sterile packaging, to slide easily off the edge without the worry of snagging or tearing.

| WATERFALL EDGE SHELVES | | |
|------------------------|-------------|------------|
| CHROME | D x W - IN. | MAXWT LBS. |
| 2448CHWF | 24 x 48 | 600 |
| 2460CHWF | 24 x 60 | 520 |
| 2472CHWF | 24 x 72 | 320 |

Wire Shelf (Chrome)

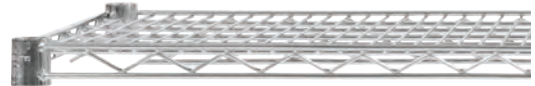

Waterfall Edge Shelf

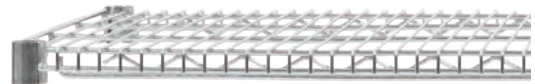

Solid Shelf



SLIDE-OUT SHELVES

LogiQuip **Flat Wire Slide-Out Shelf** offers easy access to lower items and keeps bins secure with a rear lip—perfect for **Plastic Two-Bin Systems**.

| SLIDE OUT SHELVES | | |
|-------------------|-------------|------------|
| CHROME | D x W - IN. | MAXWT LBS. |
| 2436CHSO | 24 x 36 | 100 |
| 2448CHSO | 24 x 48 | 100 |
| 2460CHSO | 24 x 60 | 100 |



SOLID SHELVES

Solid Shelves are available in 18" and 24" deep in both **Stainless Steel** and **Galvanized Steel**.

| SOLID SHELVES | | | |
|---------------|------------|-------------|------------|
| STAINLESS | GALVANIZED | D x W - IN. | MAXWT LBS. |
| 1836SS | 1836GS | 18 x 36 | 800 |
| 1848SS | 1848GS | 18 x 48 | 800 |
| 2436SS | 2436GS | 24 x 36 | 800 |
| 2448SS | 2448GS | 24 x 48 | 800 |
| 2460SS | 2460GS | 24 x 60 | 600 |

LQS COMPONENTS

SPLIT SLEEVES

Split Sleeves snap around grooves of the Post to hold a Shelf. Four (4) Split Sleeves are included with each Shelf.

| SPLIT SLEEVES | |
|---------------|-------------|
| MODEL | DESCRIPTION |
| PBAG | Plastic |



CANTILEVER BRACKET

The Cantilever Bracket is used to mount Shelves to the Post of Wall Mounting Shelves and available in three sizes.

| CANTILEVER BRACKET | |
|--------------------|-----------|
| MODEL | DIMENSION |
| SMB14CH | 14" |
| SMB18CH | 18" |
| SMB24CH | 24" |



POSTS

All Posts are numbered and adjustable on 1-inch increments. One (1) Leveling Foot is needed for each Post. Posts can be ordered without Leveling Feet for stem caster applications. Includes one cap per Post. Special Post lengths are available for a nominal cutting charge.

| 1" POSTS | | | | |
|---------------|-----------------------------|--------------------------|-----------------------------|------|
| LEVELING FOOT | OPEN BOTTOM FOR STEM CASTER | EPOXY COATED OPEN BOTTOM | STAINLESS STEEL OPEN BOTTOM | HIGH |
| P14CH-CL | P14CH-CO | — | — | 14" |
| P27CH-CL | P27CH-CO | — | — | 27" |
| P30CH-CL | P30CH-CO | — | — | 30" |
| P34CH-CL | P34CH-CO | — | — | 34" |
| P54CH-CL | P54CH-CO | — | — | 54" |
| P74CH-CL | P74CH-CO | — | P74SS | 74" |
| P86CH-CL | P86CH-CO | — | — | 86" |



WIRE BASKETS

Choose from 18" or 24" deep Wire Baskets that attach directly to the Posts. Dividers and Rods are available in two sizes to maximize storage and organization. See page 24 for model numbers.

| 18" DEEP | | |
|----------|-----------------|-----------------|
| MODEL | DESCRIPTION | D x W x H - IN. |
| SB2024CH | 24" Wire Basket | 18 x 24 x 10 |
| SB2036CH | 36" Wire Basket | 18 x 36 x 10 |
| SB2048CH | 48" Wire Basket | 18 x 48 x 10 |
| SB2060CH | 60" Wire Basket | 18 x 60 x 10 |

| 24" DEEP | | |
|----------|-----------------|-----------------|
| MODEL | DESCRIPTION | D x W x H - IN. |
| SB2424CH | 24" Wire Basket | 24 x 24 x 10 |
| SB2436CH | 36" Wire Basket | 24 x 36 x 10 |
| SB2448CH | 48" Wire Basket | 24 x 48 x 10 |
| SB2460CH | 60" Wire Basket | 24 x 60 x 10 |

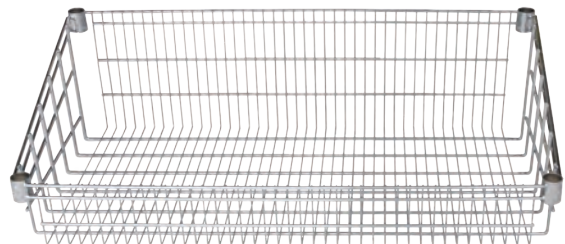

Model #
SB2024CH

LQS COMPONENTS

DOLLY BASES

LogiQuip Dolly Bases are heavy-duty with a non-marking, wrap-around bumper. Dolly Bases have a Fully Enclosed Top that adheres to infection control standards and functions as a solid bottom Shelf which eliminates the additional Wire Shelf requirement.

| FULLY ENCLOSED TOP DOLLY BASES | |
|--------------------------------|-------------|
| MODEL | D X W - IN. |
| DB1836 | 18 x 36 |
| DB1848 | 18 x 48 |
| DB1860 | 18 x 60 |
| DB1872 | 18 x 72 |
| DB2436 | 24 x 36 |
| DB2448 | 24 x 48 |
| DB2460 | 24 x 60 |
| DB2472 | 24 x 72 |



Fully Enclosed Top Dolly Base

PLATE/STEM CASTERS & DONUT BUMPERS

LogiQuip Casters come in two options – Plate and Stem. Plate Casters are for use with Dolly Bases. The 5” Casters are made of non-marking polyurethane and the 6” Casters are designed for heavy-duty transport with premium ergonomic elastomere and are also non-marking.

5” Stem Casters are designed to be used with Posts, and are non-marking. Donut Bumpers are for use with Stem Casters and also non-marking polyurethane. Stem Casters are also offered in sets (see chart for details).

| 5" PLATE CASTERS | | | | |
|------------------|---------------|--------------|-----------|---------------|
| MODEL | CART WASHABLE | DESCRIPTION | WHEEL DIA | MAX WT - LBS. |
| CB5 | CSB5PS | Swivel/Brake | 1.25" | 250 |
| C5 | CSS5PS | Swivel | 1.25" | 250 |

| 6" PLATE CASTERS | | | | |
|------------------|--------------|-----------|--------------|--|
| MODEL | DESCRIPTION | WHEEL DIA | MAX WT - LBS | |
| 31-76BXR | Swivel/Brake | 2" | 800 | |
| 31-76FPXR | 4-Postion | 2" | 800 | |
| 31-76RXSR | Rigid | 2" | 800 | |
| 31-76XSR | Swivel | 2" | 800 | |

| STEM HORN CASTERS | | | | |
|-------------------|-----------|--------------|-----------|--------------|
| STEEL | STAINLESS | DESCRIPTION | WHEEL DIA | MAX WT - LBS |
| 5CB-LQS | 5CBSS-LQS | Swivel/Brake | 1.25" | 250 |
| 5C-LQS | 5CSS-LQS | Swivel | 1.25" | 250 |

| CASTER SETS & BUMPERS | | | | |
|-----------------------|--------------------------------|-----------|--------------|--|
| MODEL | DESCRIPTION | WHEEL DIA | MAX WT - LBS | |
| 5C/5CB-LQS | Set of 2 Brake, 2 Swivel/Brake | 1.25" | 1000 | |
| RDB325 | Donut Bumper, 3.5" | — | — | |



LQS ACCESSORIES

SHELF COVERS

Shelf Covers come in two (2) options – Snap-On or Flat. All Shelf Covers are made from white poly material and adhere to standards without the extra cost. Epoxy-Coated and Stainless Steel Shelf Covers are also available. Contact your Representative for more information.

| 14" DEEP | |
|----------|-------------|
| FLAT | D X W - IN. |
| AM1424PF | 14 x 24 |
| AM1436PF | 14 x 36 |
| AM1448PF | 14 x 48 |
| AM1460PF | 14 x 60 |

| 18" DEEP | |
|----------|-------------|
| FLAT | D X W - IN. |
| AM1824PF | 18 x 24 |
| AM1830PF | 18 x 30 |
| AM1836PF | 18 x 36 |
| AM1842PF | 18 x 42 |
| AM1848PF | 18 x 48 |
| AM1854PF | 18 x 54 |
| AM1860PF | 18 x 60 |
| AM1872PF | 18 x 72 |

| 24" DEEP | |
|----------|-------------|
| FLAT | D X W - IN. |
| AM2424PF | 24 x 24 |
| AM2430PF | 24 x 30 |
| AM2436PF | 24 x 36 |
| AM2442PF | 24 x 42 |
| AM2448PF | 24 x 48 |
| AM2454PF | 24 x 54 |
| AM2460PF | 24 x 60 |
| AM2472PF | 24 x 72 |

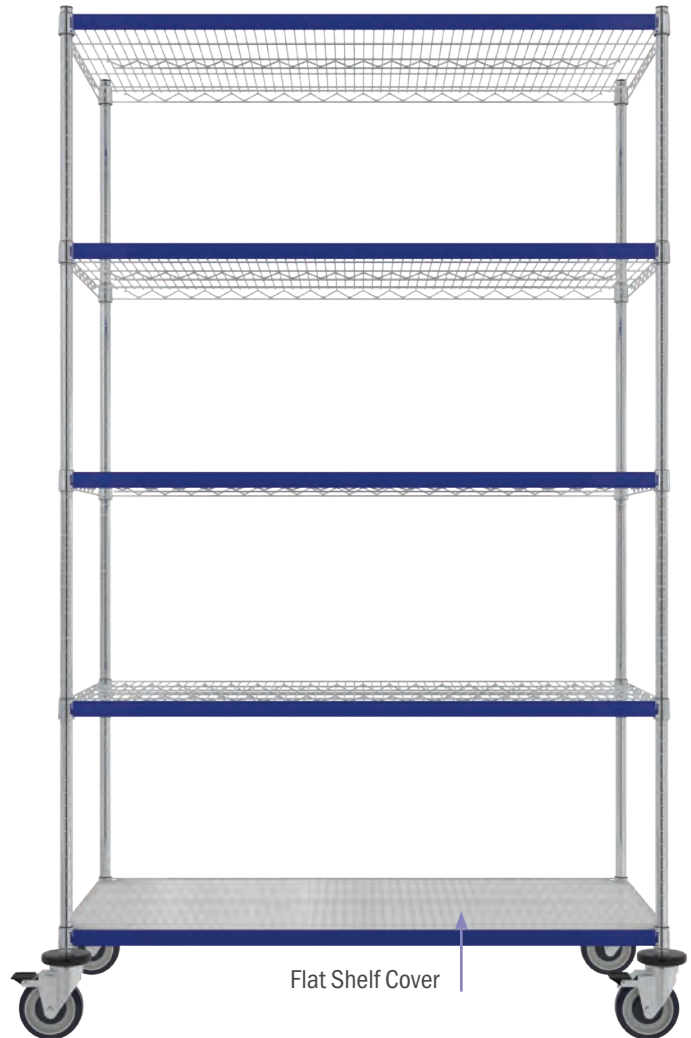

LQS ACCESSORIES

The LogiQuip® patented **Kanban Flipper System** creates a **Kanban Trigger** when the caregiver accesses the safety stock by lowering the **Kanban Flipper**, creating a visual cue to order more supplies. Available in 6" or 8.5" depths, our **Kanban Flippers** can be used with our **ParWire** and **ParWall Fine Mesh Baskets Shelves**, **LQS Flat Wire Shelves**, and **Waterfall Edge Shelves**. Use the **Kanban Adaptor** to attach the **Kanban Flipper** to **LQS Flat Wire** or **Waterfall Edge Shelving**.

KANBAN FLIPPERS WITH CLIPS & LABELS

- Four (4) Label sizes are available (see below)
- Use the 6" deep Flipper for 12" and 18" deep Fine Mesh Basket Shelving and 18" and 24" LQS Flat Wire and Waterfall Edge Shelving.
- Use the 8.5" deep Flipper for 24" deep Fine Mesh Basket, LQS Flat Wire, and Waterfall Edge Shelving
- Available as Singles and includes REORDER Labels

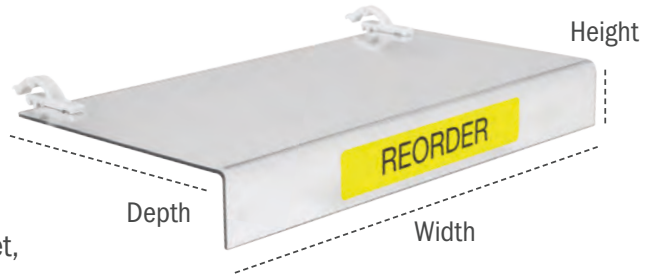

MODEL # DVKB126B-1

| KANBAN FLIPPER WITH CLIPS & LABELS | | |
|------------------------------------|-----------------------------------|------------------|
| 1-PACK | DESCRIPTION | W x D x H - IN. |
| DVKB26-1 | (1) Flipper, (2) Clips, (1) Label | 1.75 x 6 x 1.5 |
| DVKB36-1 | (1) Flipper, (2) Clips, (1) Label | 2.75 x 6 x 1.5 |
| DVKB38-1 | (1) Flipper, (2) Clips, (1) Label | 2.75 x 8.5 x 1.5 |
| DVKB46-1 | (1) Flipper, (2) Clips, (1) Label | 3.75 x 6 x 1.5 |
| DVKB48-1 | (1) Flipper, (2) Clips, (1) Label | 3.75 x 8.5 x 1.5 |
| DVKB66B-1 | (1) Flipper, (2) Clips, (1) Label | 5.75 x 6 x 1.5 |
| DVKB68B-1 | (1) Flipper, (2) Clips, (1) Label | 5.75 x 8.5 x 1.5 |
| DVKB96B-1 | (1) Flipper, (2) Clips, (1) Label | 8.75 x 6 x 1.5 |
| DVKB98B-1 | (1) Flipper, (2) Clips, (1) Label | 8.75 x 8.5 x 1.5 |
| DVKB126B-1 | (1) Flipper, (2) Clips, (1) Label | 11.75 x 6 x 1.5 |

| KANBAN FLIPPER WITH CLIPS & LABELS | | |
|------------------------------------|-----------------------------------|-------------------|
| 1-PACK | DESCRIPTION | W x D x H - IN. |
| DVKB128B-1 | (1) Flipper, (2) Clips, (1) Label | 11.75 x 8.5 x 1.5 |
| DVKB186B-1 | (1) Flipper, (3) Clips, (1) Label | 17.75 x 6 x 1.5 |
| DVKB188B-1 | (1) Flipper, (3) Clips, (1) Label | 17.75 x 8.5 x 1.5 |
| DVKB206B-1 | (1) Flipper, (3) Clips, (1) Label | 20 x 6 x 1.5 |
| DVKB208B-1 | (1) Flipper, (3) Clips, (1) Label | 20 x 8.5 x 1.5 |
| DVKB246B-1 | (1) Flipper, (4) Clips, (1) Label | 24 x 6 x 1.5 |
| DVKB248B-1 | (1) Flipper, (4) Clips, (1) Label | 24 x 8.5 x 1.5 |
| DVKB356B-1 | (1) Flipper, (4) Clips, (1) Label | 35 x 6 x 1.5 |
| DVKB358B-1 | (1) Flipper, (4) Clips, (1) Label | 35 x 8.5 x 1.5 |

KANBAN LABELS

Kanban Labels are available in four (4) sizes for easy application onto **Kanban Flippers**. Simply peel and stick. These have a matte finish to minimize the glare from overhead lights and can withstand heavy-duty cleaners. Available in a pack of one or 25.

| KANBAN LABELS | | |
|---------------|------------|--------------|
| PACK OF 1 | PACK OF 25 | W X H - IN. |
| LHKB21 | LHKB225 | 1.75 x 1.25 |
| LHKB41 | LHKB425 | 3.75 x 1.25 |
| LHKB61 | LHKB625 | 5.75 x 1.25 |
| LHKB181 | LHKB1825 | 17.75 x 1.25 |



LQS ACCESSORIES

KANBAN ADAPTOR

The patented Kanban Adaptor allows the Kanban Flipper to attach to LQS Standard Wire and Waterfall Edge Shelving.

| KANBAN ADAPTOR | |
|----------------|--|
| MODEL | |
| DVKBADAPTOR-2 | |



INTELI-FLIP® SYSTEM

Take Lean to the next level with LogiQuip's patented Intelli-Flip System. Combined with our Fine Mesh Basket Shelving, Dividers, and Kanban Flipper products, Intelli-Flip provides system-driven, up-to-date inventory management based on Lean principles.

| INTELI-FLIP SYSTEM | |
|--------------------|-------------|
| MODEL | DESCRIPTION |
| IFM2-STD | Monitor |
| IFC2-CELL | Controller |



Model #
IFM2-STD



Model #
IFC2-CELL

3-SIDED FRAMES

Nickel-Chrome Plated 3-Sided Frames attach directly to standard Posts to increase stability and support.

| 3-SIDED FRAMES | |
|----------------|-------------|
| MODEL | D x W - IN. |
| TSF1836CH | 18 x 36 |
| TSF1848CH | 18 x 48 |
| TSF1860CH | 18 x 60 |
| TSF2436CH | 24 x 36 |
| TSF2448CH | 24 x 48 |
| TSF2460CH | 24 x 60 |



Model #
TSF1836CH

LABEL HOLDERS FOR WATERFALL EDGE SHELVING

Waterfall Label Holders are available in three (3) sizes and have a clear front cover with either Clear (CL) or Blue (BL) color support.

| WATERFALL EDGE SHELVING LABEL HOLDERS | | |
|---------------------------------------|----------|------|
| BLUE | CLEAR | WIDE |
| LH48BLWF | LH48CLWF | 48" |
| LH60BLWF | LH60CLWF | 60" |
| LH72BLWF | LH72CLWF | 72" |



Also available in
Clear (CL)

LQS ACCESSORIES – LABEL HOLDERS

3-INCH LABEL HOLDERS FOR WIRE SHELVING

Our wide variety of **3-Inch Label Holder** colors aid in color coding inventory, making supplies easier to find. These 1" W x 3" H **Label Holders** include a loop for attaching to **Shelves** or **Baskets**, come in bags of 50, and can be used on **ParWire Basket Shelving** and **LQS Shelving**. Choose from 9 colors; Blue, Red, Pink, Yellow, Orange, Green, Purple, Black, and White.



Model #
LH3-BLUE

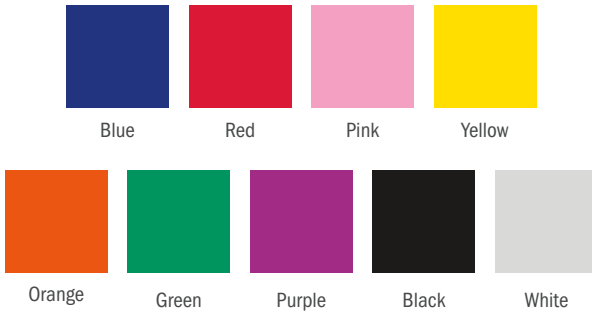

(Actual color may vary, depending on your monitor setting or press run.)

| 3-INCH LABEL HOLDERS | |
|----------------------|--------|
| MODEL | COLOR |
| LH3-BLUE | Blue |
| LH3-RED | Red |
| LH3-PINK | Pink |
| LH3-YELLOW | Yellow |
| LH3-ORANGE | Orange |
| LH3-GREEN | Green |
| LH3-PURPLE | Purple |
| LH3-BLACK | Black |
| LH3 | White |

LABEL HOLDER FOR WIRE BASKETS

Label Holders for Wire Baskets are available in four (4) sizes and two colors; **Clear (CL)** or **Blue (BL)**.

Easily label supplies with our **Blue Label Holders** for **ParWire Fine Mesh** and **LQS Supply Basket Shelves** (shown below).



Blue Label

| WIRE BASKET LABEL HOLDERS | | |
|---------------------------|------------|------|
| BLUE | CLEAR | WIDE |
| LH24BLPRSB | LH24CLPRSB | 24" |
| LH36BLPRSB | LH36CLPRSB | 36" |
| LH48BLPRSB | LH48CLPRSB | 48" |
| LH60BLPRSB | LH60CLPRSB | 60" |

LABEL HOLDER FOR SUTURE SHELVES

Suture Shelf Label Holders are available in three sizes. **Single-Sided Shelves** will use one (1) **Label Holder** and **Double-Sided Shelves** will use two (2) **Label Holders**, one on each side.

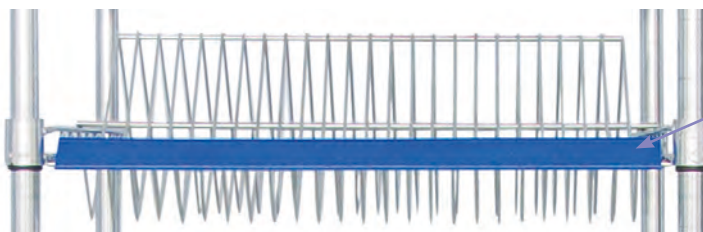

| SUTURE LABEL HOLDERS | |
|----------------------|------|
| MODEL | WIDE |
| STRLH24BL | 24" |
| STRLH36BL | 36" |
| STRLH48BL | 48" |

LQS ACCESSORIES – LABEL HOLDERS

3-POSITION LABEL HOLDERS FOR WIRE SHELVING

Wire Shelving 3-Position Label Holders can be installed in three (3) positions; flat, a 10° angle or a 30° angle. These Label Holders have a clear front cover with either Clear (CL) or Blue (BL) color support.



Clear Label



Blue Label Flat



Blue Label
0° Angle

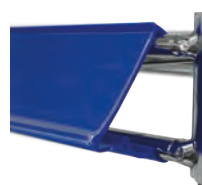

Blue Label
30° Angle

3-POSITION LABEL HOLDERS

| BLUE | CLEAR | WIDE |
|--------|--------|------|
| LH03BL | LH03CL | 3" |
| LH24BL | LH24CL | 24" |
| LH30BL | LH30CL | 30" |
| LH36BL | LH36CL | 36" |
| LH42BL | LH42CL | 42" |
| LH48BL | LH48CL | 48" |
| LH54BL | LH54CL | 54" |
| LH60BL | LH60CL | 60" |
| LH72BL | LH72CL | 72" |



Before LQS Shelving



With LQS Shelving

LQS ACCESSORIES – POST WRAPS

POST WRAP NUMBER & LETTER LABELS FOR CARTS

LogiQuip Post Wraps come in two-inch and six-inch lengths, and available with both numbers and letters. Use these Post Wraps to designate aisles and shelves in your facility. They can be moved easily from Post to Post. Custom options are available. Please contact your Sales Representative or Customer Experience Team for more information.

| 2" POST WRAP NUMBERS | |
|----------------------|-------------|
| MODEL | DESCRIPTION |
| PL2B1 | 2" BLUE 1 |
| PL2B2 | 2" BLUE 2 |
| PL2B3 | 2" BLUE 3 |
| PL2B4 | 2" BLUE 4 |
| PL2B5 | 2" BLUE 5 |
| PL2B6 | 2" BLUE 6 |
| PL2B7 | 2" BLUE 7 |
| PL2B8 | 2" BLUE 8 |
| PL2B9 | 2" BLUE 9 |
| PL2B10 | 2" BLUE 10 |

| 2" POST WRAP LETTERS | |
|----------------------|-------------|
| MODEL | DESCRIPTION |
| PL2BA | 2" BLUE A |
| PL2BB | 2" BLUE B |
| PL2BC | 2" BLUE C |
| PL2BD | 2" BLUE D |
| PL2BE | 2" BLUE E |
| PL2BF | 2" BLUE F |
| PL2BG | 2" BLUE G |
| PL2BH | 2" BLUE H |
| PL2BI | 2" BLUE I |
| PL2BJ | 2" BLUE J |

| 6" POST WRAP NUMBERS | |
|----------------------|-------------|
| MODEL | DESCRIPTION |
| PL6B1 | 6" BLUE 1 |
| PL6B2 | 6" BLUE 2 |
| PL6B3 | 6" BLUE 3 |
| PL6B4 | 6" BLUE 4 |
| PL6B5 | 6" BLUE 5 |
| PL6B6 | 6" BLUE 6 |
| PL6B7 | 6" BLUE 7 |
| PL6B8 | 6" BLUE 8 |
| PL6B9 | 6" BLUE 9 |
| PL6B10 | 6" BLUE 10 |

| 6" POST WRAP LETTERS | |
|----------------------|-------------|
| MODEL | DESCRIPTION |
| PL6BA | 6" BLUE A |
| PL6BB | 6" BLUE B |
| PL6BC | 6" BLUE C |
| PL6BD | 6" BLUE D |
| PL6BE | 6" BLUE E |
| PL6BF | 6" BLUE F |
| PL6BG | 6" BLUE G |
| PL6BH | 6" BLUE H |
| PL6BI | 6" BLUE I |
| PL6BJ | 6" BLUE J |

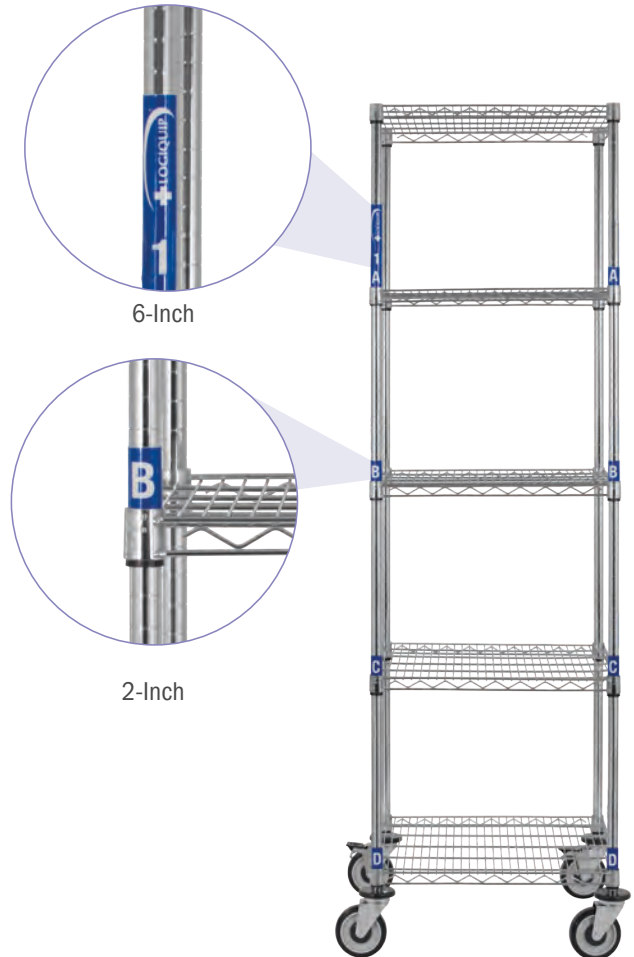

POST WRAP SUPPLY LABEL FOR CARTS

Post Wrap Supply Labels are 6-inches tall and available in six (6) options to clearly designate the category of supplies that are being stored on any Wire Shelving Unit for easy access.

| POST WRAP LABELS | |
|------------------|------------------------------------|
| BLUE | DESCRIPTION |
| PL6RESPB | 6" with Respiratory Icon, Blue |
| PL6PCG | 6" with Patient Care Icon, Green |
| PL6WCR | 6" with Wound Care Icon, Red |
| PL6PPEP | 6" with PPE Icon, Purple |
| PL6GIY | 6" with GI/GU Icon, Yellow |
| PL6GSW | 6" with General Supply Icon, White |
| PL6REHABO | 6" with Rehab Icon, Orange |



LQS ACCESSORIES – DIVIDERS & RODS

DIVIDERS FOR WIRE SHELVES & BASKETS

Dividers for Wire Shelves and Baskets are nickel-chrome plated. All designs with the 3-hook bottom fit **Standard Wire Shelves** and Wire Baskets. Dividers are available in 6” and 8” heights.

| 24” DEEP DIVIDERS | |
|-------------------|-------------|
| MODEL | D x H - IN. |
| CFDIV246 | 24 x 6 |
| CFDIV248 | 24 x 8 |

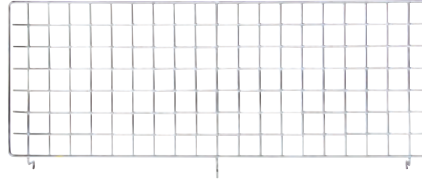

Model #
CFDIV248

DIVIDERS FOR WIRE SHELVES

Dividers for Wire Shelves are nickel-chrome plated and fit **ALL Standard Wire Shelves**. Dividers are 8” high and lock securely on the shelf with the 2-hook bottom.

| 8” HIGH DIVIDERS | |
|------------------|-------------|
| MODEL | D x H - IN. |
| D188CH | 18 x 8 |
| D248CH | 24 x 8 |

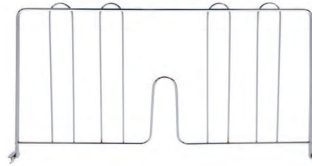

Model #
D188CH

DIVIDERS & RODS FOR WIRE BASKETS

Dividers are available in two sizes – 18” and 24”. Each Rod includes four (4) clips.

| RODS | | |
|---------|-------------|-------------|
| MODEL | DESCRIPTION | DEPTH - IN. |
| SB20RCH | 18” Rod | 18 |
| SB24RCH | 24” Rod | 24 |



| DIVIDERS | | |
|------------|-------------|-------------|
| MODEL | DESCRIPTION | D x W - IN. |
| SBDIV208CH | 18” Divider | 18 x 8 |
| SBDIV248CH | 24” Divider | 24 x 8 |

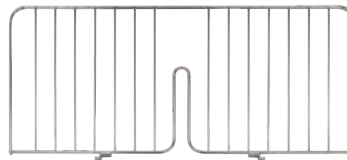

Model #
SBDIV208CH

SUTURE SHELF DIVIDERS

The Suture Shelf Dividers are available for **Single and Double Sided Shelves**.

| SUTURE DIVIDERS | |
|-----------------|--------------|
| MODEL | DESCRIPTION |
| DVSL4CH | Single Sided |
| DVSTR4CH | Double-Sided |



LANE DIVIDER

The Lane Divider is used to keep Bins inside the 2-Bin Lanes. Available for 18” and 24” deep shelves.

| LABEL DIVIDERS | |
|----------------|-------------|
| MODEL | D x W - IN. |
| LD183CH | 18 x 3 |
| LD243CH | 24 x 3 |

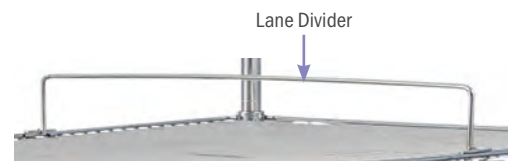

LQS ACCESSORIES

CATHETER PULL-OUT SLIDES

Pull-Out Slides are used on **Wire Carts** to easily hang catheters. The 18" comes with five (5) hooks and the 24" comes with seven (7) hooks.

| CATHETER PULL-OUT SLIDES | |
|--------------------------|------|
| MODEL | DEEP |
| USC18 | 18" |
| USC24 | 24" |



POST CLAMP

Logiquip's **Post Clamp** ties back to back **Shelving Units** together at **Posts** and is available in two sizes.

| POST CLAMP | |
|------------|-----------|
| MODEL | DIMENSION |
| CLPCH | 3" |
| CLPCH5 | 5" |



PUSH HANDLE

All-welded chrome steel tubing shallow depth **Push Handles** allow for easy transport while keeping your hands away from product.

| PUSH HANDLE | |
|-------------|-------------|
| MODEL | D x W - IN. |
| PH18CH-SH | 18 x 1 |
| PPH24CH-SH | 24 x 1 |



Model # PH18CH-SH

UTILITY CART HANDLE

The **Utility Cart Handle** has an overall height of 30" and is used in place of **Posts** for **Utility Cart** purposes.

| UTILITY CART HANDLE | | |
|---------------------|-----------|-------------|
| CHROME | STAINLESS | D x W - IN. |
| RD18CH | RD18SS | 18 x 30 |
| RD24CH | RD24SS | 24 x 30 |



LQS ACCESSORIES

SEISMIC FOOT PLATE

Seismic Footplates are approved by the California Office of Statewide Health Planning and Development.

| SEISMIC FOOT PLATE | |
|--------------------|-------------|
| MODEL | DESCRIPTION |
| SIS-SFP | 3/8" Hole |



TETHER & PSTETHER

LogiQuip TETHER[†] can be attached directly to the wall, floor, or strut. PSTETHER[‡] is required for LogiQuip ParStor Units.

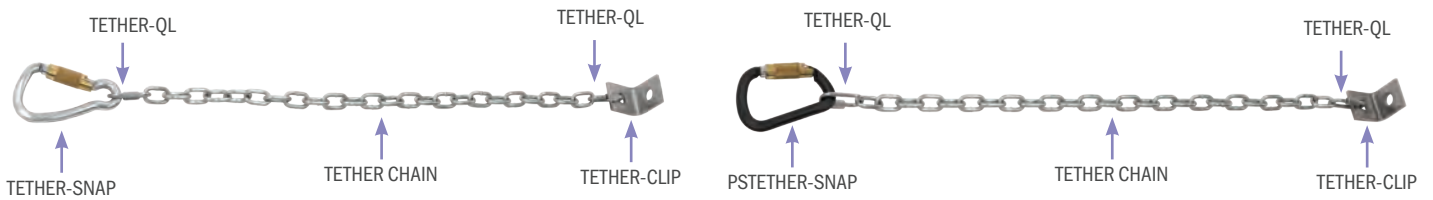

| TETHER | |
|--------------------------|--|
| MODEL | DESCRIPTION |
| TETHER-CHAIN | Grade 30 unfinished steel, 1/8 trade size, 400 lb. capacity |
| TETHER-CLIP* | Stainless steel grade 304, 1 7/8" D x 2" W x 1 5/8" H, 1/4" thick, 9/16" diameter hole |
| TETHER-QL | Type 316 stainless steel, 3/16" Thickness, 1/4" Opening, 900 lb. capacity |
| TETHER-SNAP [†] | Zinc-plated steel carabiner, 1600 lb. capacity |

*Does not include floor anchor or plate.

[†]TETHER includes TETHER-CHAIN, TETHER-CLIP, TETHER-QL AND TETHER-SNAP.

LEDGES

All Ledges can be used for either side or back, and are made from **Nickle Chrome Wire** and available in 1" and 4" high options.

| 1" LEDGES | | 4" LEDGES | |
|-----------|-------------|-----------|-------------|
| MODEL | D x H - IN. | MODEL | D x H - IN. |
| L181CH | 18 x 1 | L144CH | 14 x 4 |
| L241CH | 24 x 1 | L184CH | 18 x 4 |
| L601CH | 60 x 1 | L244CH | 24 x 4 |
| L721CH | 72 x 1 | L364CH | 36 x 4 |
| | | L484CH | 48 x 4 |
| | | L604CH | 60 x 4 |

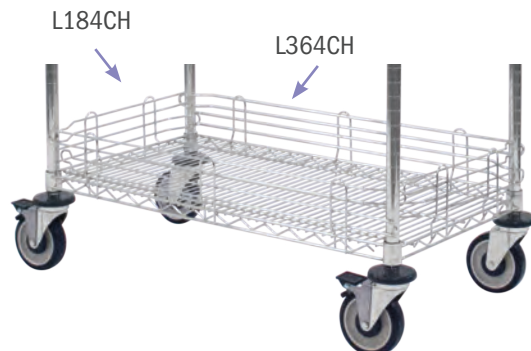

LQS ACCESSORIES – CART COVERS

CART COVERS

LogiQuip® **Carts Covers** are designed to keep your supplies clean from dust, dirt, and debris. **Cart Covers** are available in three materials; **Pro-Check Vinyl**, **400D Nylon**, and **200D Polyester**, 18 colors and a wide variety of sizes. Additional colors and custom sizes are available upon request.

AVAILABLE MATERIALS (FOR CART COVERS)

Pro-Check Vinyl is an antibacterial, anti-fungal, mildew resistant material that comes in nine colors.

400D Nylon is a high density durable fabric that is polyurethane coated and water resistant, yet is still light weight and will protect your carts from dust. There are 15 color choices for **400D Nylon Cart Covers**.

200D Polyester is an uncoated, dust cover fabric. Available in five colors, **200D Polyester** is a great alternative to **Nylon**.



Model #
CC244874RB4V

COLOR OPTIONS

The actual colors shown below may vary, depending on your monitor setting or press run.



Black



Brown



Forest Green



Khaki



Maroon



Mint Green



Navy Blue



Orange



Powder Blue



Purple



Red



Royal Blue



Silver



Tan



Turquoise

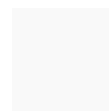

White



Yellow



Velcro Closure



Zipper Closure

LQS ACCESSORIES – CART COVERS

CART COVER MODEL NUMBERS

| CART COVER MODELS | | | | | | |
|-------------------|-----------------|--------------------------|---------------------|-------------------------|----------|----------------|
| MODEL | D x W x H - IN. | *PRO-CHECK VINYL COLOR† | *400D NYLON COLOR† | *200D POLYESTER COLOR† | CLOSURE | ADDITIONAL |
| CC183663 | 18 x 36 x 63 | BK=Black | BK=Black | BK=Black | V=Velcro | CL=Clear Front |
| CC184863 | 18 x 48 x 63 | FG=Forest Green | BR=Brown | FG=Forest Green | Z=Zipper | H=Handle |
| CC186063 | 18 x 60 x 63 | MG=Mint Green | FG=Forest Green | NB=Navy Blue | | |
| CC187263 | 18 x 72 x 63 | NB=Navy Blue | KH=Khaki | OR=Orange | | |
| CC183674 | 18 x 36 x 74 | PB=Powder Blue | MR=Maroon | RD=Red | | |
| CC184874 | 18 x 48 x 74 | RD=Red | NB=Navy Blue | RB=Royal Blue | | |
| CC186074 | 18 x 60 x 74 | RB=Royal Blue | OR=Orange | WH=White | | |
| CC187274 | 18 x 72 x 74 | WH=White | PL=Purple | YW=Yellow | | |
| CC243663 | 24 x 36 x 63 | | RD=Red | | | |
| CC244863 | 24 x 48 x 63 | | RB=Royal Blue | | | |
| CC246063 | 24 x 60 x 63 | | SV=Silver | | | |
| CC247263 | 24 x 72 x 63 | | TN=Tan | | | |
| CC243674 | 24 x 36 x 74 | *PRO-CHECK VINYL FABRIC‡ | *400D NYLON FABRIC‡ | *200D POLYESTER FABRIC‡ | | |
| CC244874 | 24 x 48 x 74 | | | | | |
| CC246074 | 24 x 60 x 74 | P=Pro-Check Vinyl | 4=400D Nylon | 2=200D Polyester | | |
| CC247274 | 24 x 72 x 74 | | | | | |

*Please add your COLOR† choice, FABRIC‡ choice, CLOSURE choice, and ADDITIONAL choice to the end of the model number in this order.
 EXAMPLE: Model CC246063 + Forest Green (FG) + 400D Nylon (4) + Zipper (Z) + Clear Front (CF) = CC246060FG4ZCL



LQS ACCESSORIES – SHELF BINS

SHELF BINS

Build out the traditional **Two-Bin** system using LogiQuip **Shelf Bins** on our **LQS Flat Wire Shelving**. These durable polypropylene **Shelf Bins** are one-piece construction and come in a variety of sizes and colors† to fit any need. **Shelf Bins** can also nest inside of one another for easy, compact storage. Cross-wise **Black Dividers** are optional and sold separately unless noted below.

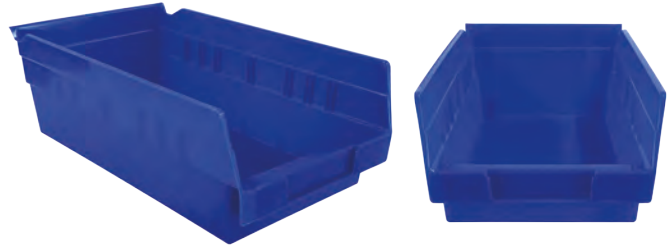

Model # SB120B

NOTE: Must order in the stated carton quantities listed below.

| SHELF BINS + DIVIDERS | | | | | |
|-----------------------|-------------------------------|---------------------|---------------------|-------------------------|-------------------------|
| MODEL | COLOR† | BIN CARTON QUANTITY | D x W x H - IN. | OPTIONAL BLACK DIVIDERS | DIVIDER CARTON QUANTITY |
| SB094 | Blue (B), Red (R) | 10 | 12 x 12 x 14 | — | — |
| SB110 | Blue (B), Red (R) | 24 | 11.625 x 2.75 x 4 | — | — |
| SB120 | Blue (B), Red (R) | 24 | 11.625 x 4.125 x 4 | SBD120 | 24 |
| SB124 | Blue (B), Red (R), Yellow (Y) | 12 | 23.625 x 4.125 x 4 | SBD120 | 24 |
| SB128 | Blue (B) | 12 | 17.875 x 4.125 x 4 | SBD120 | 24 |
| SB130 | Blue (B), Red (R) | 12 | 11.625 x 6.625 x 4 | SBD130 | 24 |
| SB138 | Blue (B) | 12 | 17.875 x 6.625 x 4 | SBD130 | 24 |
| SB150 | Blue (B), Red (R) | 12 | 11.625 X 8.375 X 4 | SBD150 | 24 |
| SB158 | Blue (B), Red (R) | 12 | 17.875 x 8.375 x 4 | SBD150 | 24 |
| SB164 | Blue (B), Yellow (Y) | 6 | 23.625 x 6.625 x 4 | SBD130 | 24 |
| SB170 | Blue (B), Red (R) | 12 | 11.625 x 11.125 x 4 | SBD170 | 24 |
| SB174 | Blue (B), Green (G) | 6 | 23.625 x 11.125 x 4 | SBD170 | 24 |
| SB178 | Blue (B) | 12 | 17.875 x 11.125 x 4 | SBD170 | 24 |
| SB184 | Blue (B), Yellow (Y) | 6 | 23.625 x 8.375 x 4 | SBD150 | 24 |

†Add the correct color code to the end of the **Storage Bin** model number. **Storage Bin** colors; B=Blue, G=Green, R=Red, Y=Yellow.



LQS ACCESSORIES – STORAGE BINS

STORAGE BINS

LogiQuip Storage Bins come in a variety of sizes and colors†. Storage Bins can be hung from our ParWall Louvered Panels, stacked, or set up as a traditional Two-Bin system. Dividers are available for select storage Bins, and sold separately.

NOTE: Must order in the stated carton quantities listed below.

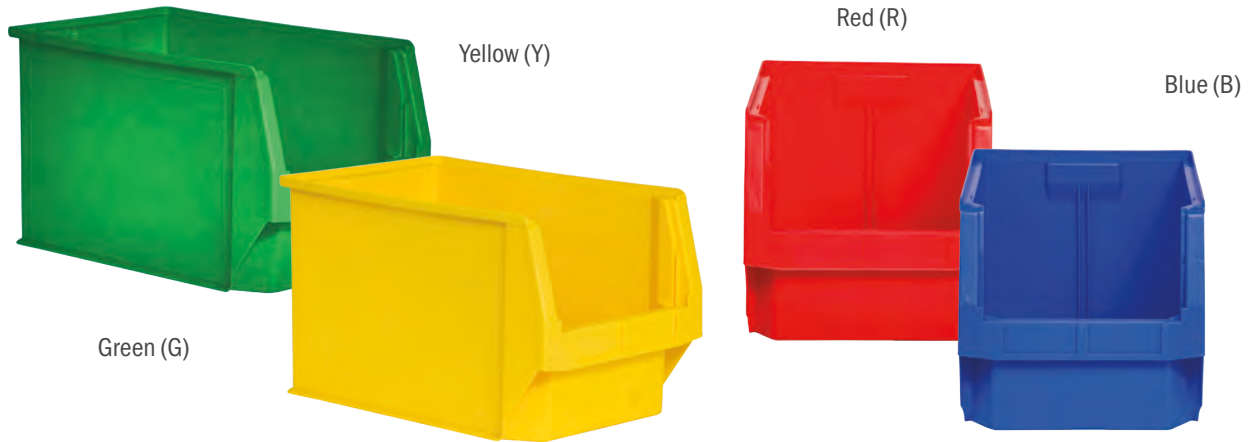

| STORAGE BINS + DIVIDERS | | | | | |
|-------------------------|--|---------------------|--------------------|-------------------------|-------------------------|
| MODEL | COLOR† | BIN CARTON QUANTITY | D x W x H - IN. | OPTIONAL BLACK DIVIDERS | DIVIDER CARTON QUANTITY |
| B165 | Yellow (Y) | 6 | 18 x 8.25 x 9 | — | — |
| B210 | Blue (B), Green (G) | 24 | 6.5 x 4.3 x 3 | — | — |
| B220 | Blue (B) | 24 | 7.378 x 4.125 x 3 | D220 | 1 |
| B224 | Blue (B), Red (R) | 12 | 10.875 x 4.125 x 4 | D224-6 | 6 |
| B230 | Blue (B), Red (R), Yellow (Y) | 12 | 10.875 x 5.5 x 5 | D230 | 6 |
| B234 | Blue (B), Green (G) | 12 | 14.75 x 5.5 x 5 | D234-6 | 6 |
| B235 | Blue (B), Red (R), Yellow (Y) | 6 | 10.875 x 11 x 5 | D230 | 6 |
| B239 | Blue (B), Green (G), Red (R), Yellow (Y) | 6 | 10.75 x 8.25 x 7 | — | — |
| B240 | Blue (B), Red (R) | 12 | 14.75 x 8.25 x 7 | D245 | 6 |
| B250 | Blue (B), Yellow (Y) | 6 | 14.75 x 16.5 x 7 | D245 | 6 |
| B271 | Blue (B) | 3 | 18 x 16.5 x 11 | — | — |
| B280 | Blue (B) | 1 | 19.7 x 12.3 x 11.9 | — | — |

| STORAGE BINS | | | |
|--------------|--|----------------|--------------------|
| MODEL | COLOR† | BIN CARTON QTY | D x W x H - IN. |
| B6-1 | Blue (B), Green (G), Red (R), Yellow (Y) | 1 | 25.6 x 18.6 x 11.8 |
| 30-255 | Blue (B), Red (R) | 6 | 10.88 x 16.5 x 5 |
| 30-260 | Blue (B), Green (G), Red (R), Yellow (Y) | 6 | 18 x 11 x 10 |
| 30-288 | Blue (B) | 1 | 24 x 16.5 x 11 |



MODEL# 30-255R

†Add the correct color code to the end of the Storage Bin model number. Storage Bin colors; B=Blue, G=Green, R=Red, Y=Yellow.



(800) 665-3760 | customerexperience@logiquip.net

LWSC-PM-02-26